

WEH000802A OLED Character 8x2

Dimension drawing

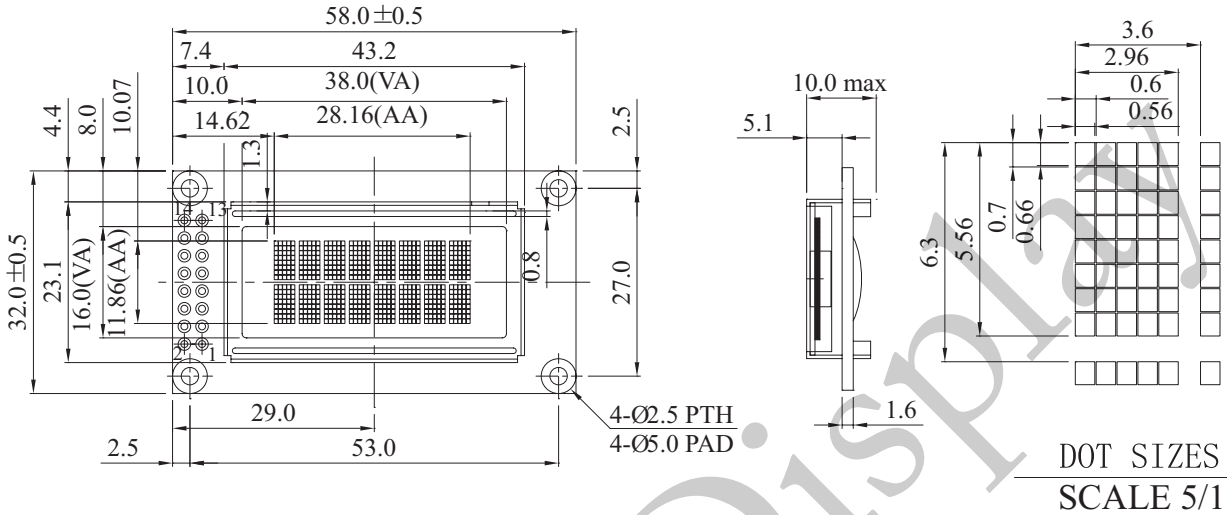

Feature

1. 8x2 dots includes cursor
2. Built-in Controller WS0010
3. +5V power supply, +3V optional
4. 1/16 duty cycle
5. Interface: 6800, option 8080 & SPI
6. Sunlight readable & polarizer optional

Pin No.	Symbol	Description
1	VSS	Ground
2	VDD	Supply Voltage for logic
3	NC	
4	RS	H: DATA, L: Instruction code
5	R/W	H: Read(MPU←Module) L: Write(MPU→Module)
6	E	H→L Enable signal
7	DB0	Data bit 0
8	DB1	Data bit 1
9	DB2	Data bit 2
10	DB3	Data bit 3
11	DB4	Data bit 4
12	DB5	Data bit 5
13	DB6	Data bit 6
14	DB7	Data bit 7
15	NC	
16	NC	

Mechanical Date

Item	Dimension	Unit
Module dimension	58.0 x 32.0 x 10.0(MAX)	mm
View area	38.0 x 16.0	mm
Active area	28.16 x 11.86	mm
Mounting hole	53.0 x 27.0	mm
Dot size	0.56 x 0.66	mm
Dot pitch	0.60x 0.70	mm
Character size	2.96 x 5.56	mm
Character pitch	3.6 x 6.3	mm

Absolute Maximum Rating

Item	Symbol	Min	Max	Unit	Notes
Input Voltage	V _I	-0.3	VDD	V	
Supply Voltage For Logic	VDD-V _{SS}	-0.3	5.3	V	

Electronical Characteristics

Item	Symbol	Condition	Min	Typ	Max	Unit
Supply Voltage For Logic	VDD-VSS	-	3.0	5.0	5.3	V
Input High Volt.	V _{IH}	-	0.9 VDD	-	VDD	V
Input Low Volt.	V _{IL}	-	GND	-	0.1VDD	V
Output High Volt.	V _{OH}	I _{OH} =-0.5mA	0.8 VDD	-	VDD	V
Output Low Volt.	V _{OL}	I _{OL} =0.5mA	GND	-	0.2 VDD	V
Supply Current	I _{DD}	VDD=5V	-	16	-	mA

OLED Character type